

NIGHTSTAND, DRESSER

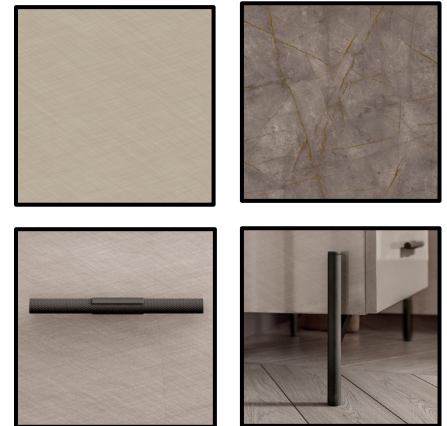
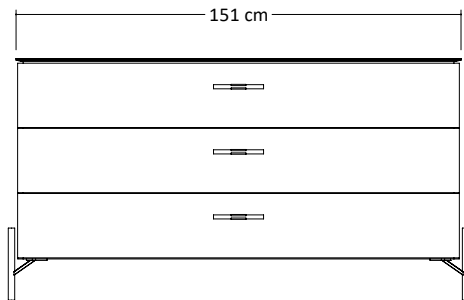
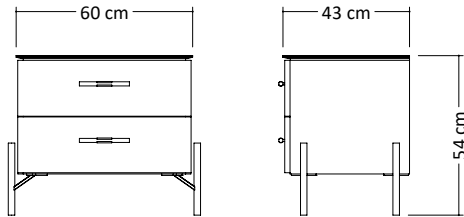

Top	<ul style="list-style-type: none"> • 10mm thick, CDF High density wood fibreboard covered with low-pressure laminate (LPL) Gold Marble matt color finish • Inner top: 28mm thick, engineered wood panel covered with low-pressure laminate (LPL) Anthracite color finish. 1mm thick, ABS edges
Bottom	22mm thick, engineered wood panel covered with low-pressure laminate (LPL) Rope color finish. 1mm thick, ABS edges
Side panels	18mm thick, engineered wood panel covered with low-pressure laminate (LPL) Rope color finish, high gloss acrylic lacquer. 1mm thick, ABS edges
Back panel	18mm thick, engineered wood panel covered with low-pressure laminate (LPL) Rope color finish. 1mm thick, ABS edges
Drawers	<ul style="list-style-type: none"> • Front: 18mm thick, engineered wood panel covered with low-pressure laminate (LPL) Rope color finish, high gloss acrylic lacquer. 1mm thick, ABS edges • Inside: 12mm thick, engineered wood panel covered with low-pressure laminate (LPL) Textured finish. Folding system • Bottom: 4mm thick, double-sided laminated MDF • Metal sliding guides with soft motion and closing system
Handles	Iron, Anthracite matt color finish
Feet	Iron, Anthracite matt color finish. H. 140mm

Cleaning:

- **Please use a damp cloth and mild liquid detergent.**
- **Do not use abrasive sponges that can flatten the surfaces. Please use a soft cloth.**
- **Do not use powder detergent or abrasive products, bleach or highly chlorinated substances, acids and strong bases.**

STORAGE UNIT

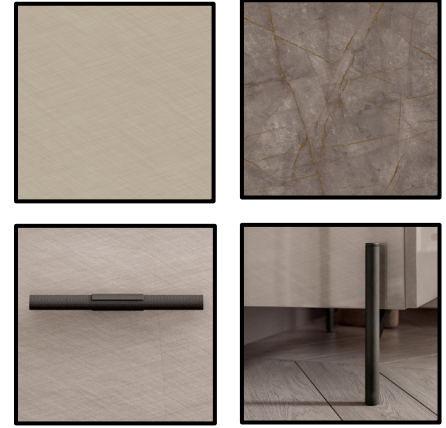
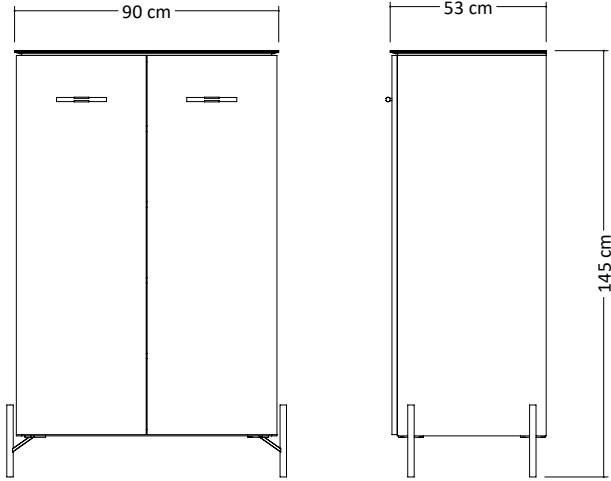

Top	<ul style="list-style-type: none"> • 10mm thick, CDF High density wood fibreboard covered with low-pressure laminate (LPL) Gold Marble matt color finish • Inner top: 28mm thick, engineered wood panel covered with low-pressure laminate (LPL) Anthracite color finish. 1mm thick, ABS edges
Bottom	22mm thick, engineered wood panel covered with low-pressure laminate (LPL) Rope color finish. 1mm thick, ABS edges
Side panels	18mm thick, engineered wood panel covered with low-pressure laminate (LPL) Rope color finish, high gloss acrylic lacquer. 1mm thick, ABS edges
Back panel	18mm thick, engineered wood panel covered with low-pressure laminate (LPL) Rope color finish. 1mm thick, ABS edges
Wooden Shelves	18mm thick, engineered wood panel covered with low-pressure laminate (LPL) Rope color finish. 1mm thick, ABS edges
Doors	18mm thick, engineered wood panel covered with low-pressure laminate (LPL) Rope color finish, high gloss acrylic lacquer. 1mm thick, ABS edges
Handles	Iron, Anthracite matt color finish
Feet	Iron, Anthracite matt color finish. H. 140mm

Cleaning:

- **Please use a damp cloth and mild liquid detergent.**
- **Do not use abrasive sponges that can flatten the surfaces. Please use a soft cloth.**
- **Do not use powder detergent or abrasive products, bleach or highly chlorinated substances, acids and strong bases.**

BED QS/160/180/KS

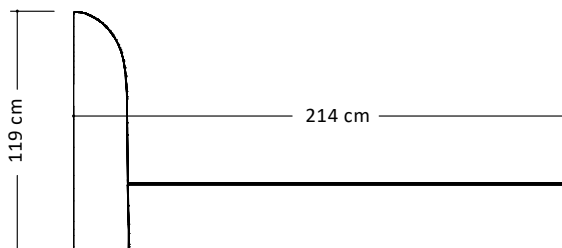
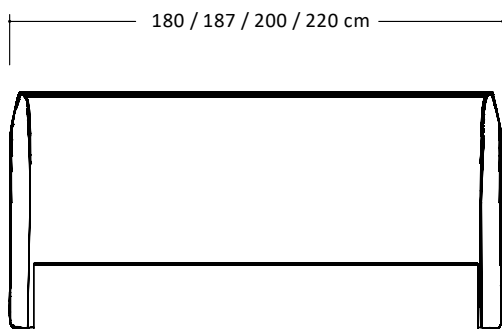

Sand



Moka

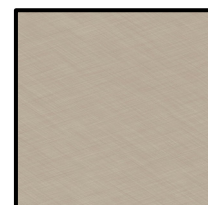

Siderails / Footboard	28mm thick, engineered wood panel covered with low-pressure laminate (LPL) Rope color finish, high gloss acrylic lacquer. 1mm thick, ABS edges
Upholstery headboard	Fire resistant fabric (100% PL). Color reference: Norris 03 (Sand) and Norris 05 (Moka)
Feet	Fiberglass ABS. Anthracite color finish. H. 50mm

Cleaning:

- *Please use a damp cloth and mild liquid detergent.*
- *Do not use abrasive sponges that can flatten the surfaces. Please use a soft cloth.*
- *Do not use powder detergent or abrasive products, bleach or highly chlorinated substances, acids and strong bases.*

MIRROR

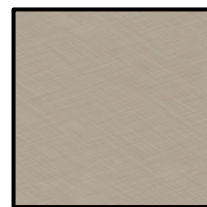
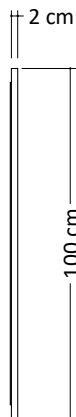
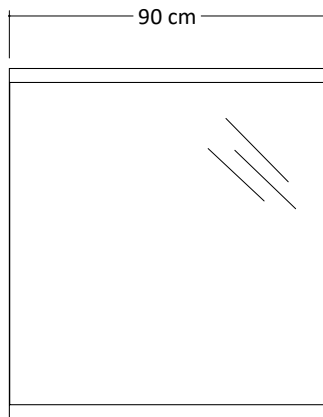

Panel	18mm thick, engineered wood panel covered with low-pressure laminate (LPL) Rope color finish, high gloss acrylic lacquer. 1mm thick, ABS edges
Mirror	3mm thick

Cleaning:

- **Please use a damp cloth and mild liquid detergent.**
- **Do not use abrasive sponges that can flatten the surfaces. Please use a soft cloth.**
- **Do not use powder detergent or abrasive products, bleach or highly chlorinated substances, acids and strong bases.**

WARDROBES

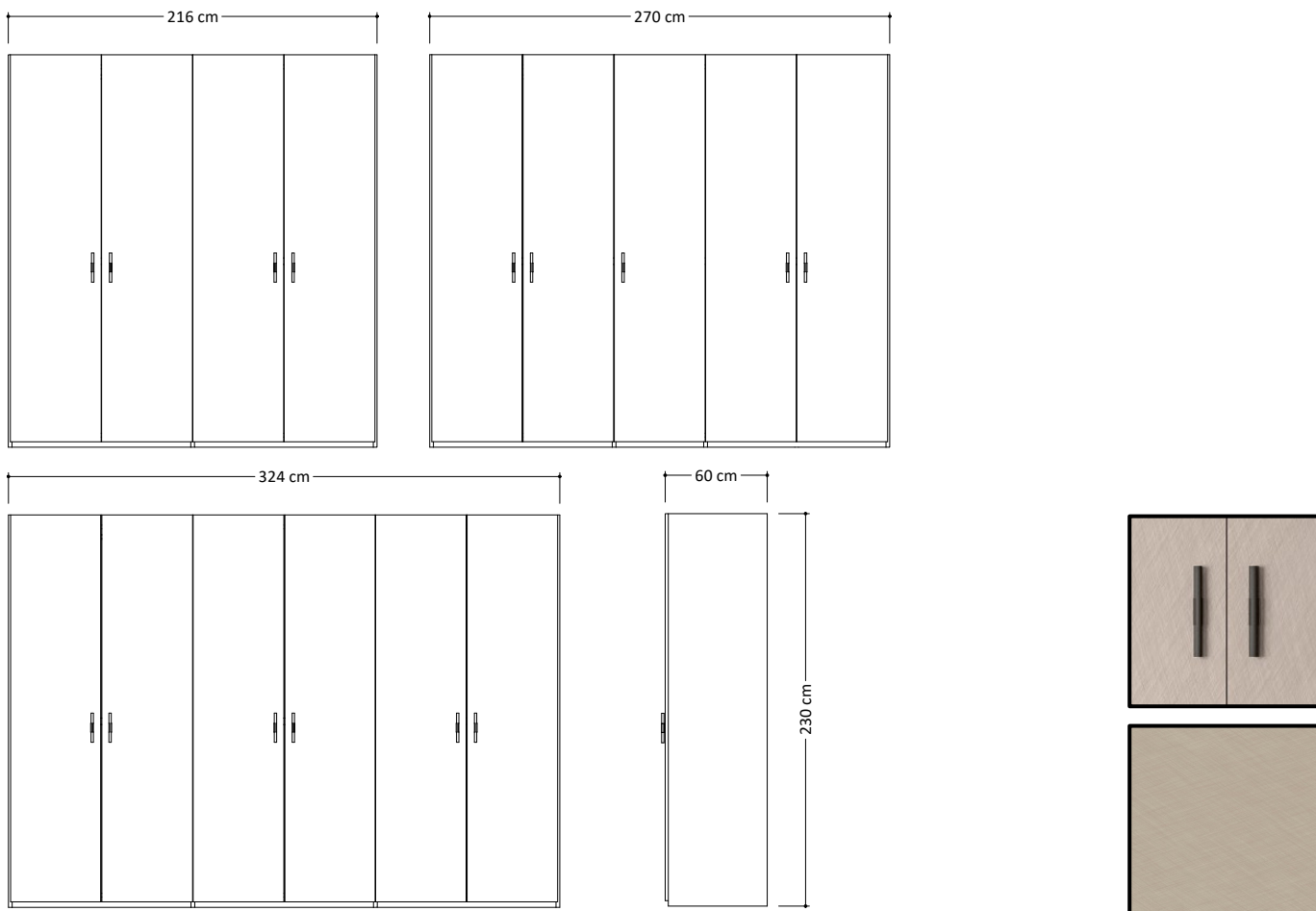

Top	22mm thick, engineered wood panel covered with low-pressure laminate (LPL) Rope color finish. 1mm thick, ABS edges
Bottom	22mm thick, engineered wood panel covered with low-pressure laminate (LPL) Rope color finish. 1mm thick, ABS edges
Sides Panels	22mm thick, engineered wood panel covered with low-pressure laminate (LPL) Rope color finish, high gloss acrylic lacquer. 1mm thick, ABS edges
Divisions	22mm thick, engineered wood panel covered with low-pressure laminate (LPL) Rope color finish. 1mm thick, ABS edges
Shelves	28mm thick, engineered wood panel covered with low-pressure laminate (LPL) Rope color finish. 1mm thick, ABS edges
Doors	18mm thick, engineered wood panel covered with low-pressure laminate (LPL) Rope color finish, high gloss acrylic lacquer. 1mm thick, ABS edges
Mirror for doors	3mm thick
Back Panel	4mm thick, double-sided laminated MDF
Handles	Iron, Anthracite matt color finish
Hinges	Metal, soft closing mechanism. Metal screw covers
Feet	Hi-Tech hidden feet, adjustable from inside of the wardrobe

BED CROSSBARS (Optional)

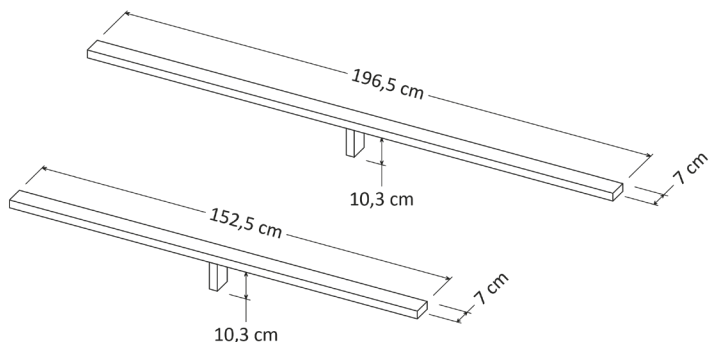

Material

30mm thick, raw spruce wood

Our furniture is made in compliance with the following regulations:

UNI EN 14749



The standard specifies the safety requirements and test methods for the structures of all types of domestic, kitchen and bathroom storage furniture and their components.

ASTM F2057-19

Standard Safety Specification for Clothing Storage Units

This safety specification is intended to reduce injuries and deaths of children from hazards associated with tip over of clothing storage units, it covers chests, drawer chests, chests of drawers, dressers, and bureaus only.

The procedures for stability testing of the drawer are presented in details. During the test, the unit shall not tip over or be supported only by an opened drawer, opened door, or opened or unopened flap.

WARNING	
	<p>Children have died from furniture tipover. To reduce the risk of furniture tipover:</p> <ul style="list-style-type: none">• ALWAYS install tipover restraint provided.• NEVER put a TV on this product.• NEVER allow children to stand, climb or hang on drawers, doors, or shelves.• NEVER open more than one drawer at a time.• Place heaviest items in the lowest drawers.
	<p>This is a permanent label. Do not remove!</p>